

Design your own custom top.

On this and on the accompanying design sheet you will find many ideas creating custom antique automobiles. All drawings are interchangeable and reversible. Merely turn the sheet over to reverse the direction or application of the component. A part of the fun in making custom antique cars is in naming them and coloring them. When finished, they make attractive and distinctive wall decorations.

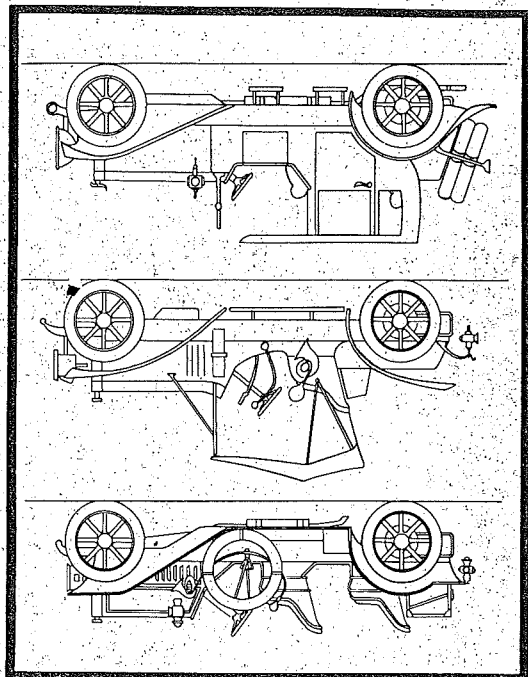

©L.I. Inc.

Below are shown only 3 ideas for drawings. Design others.

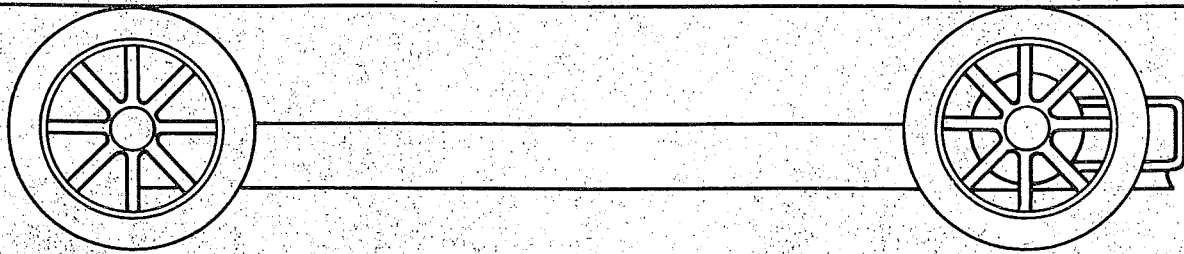
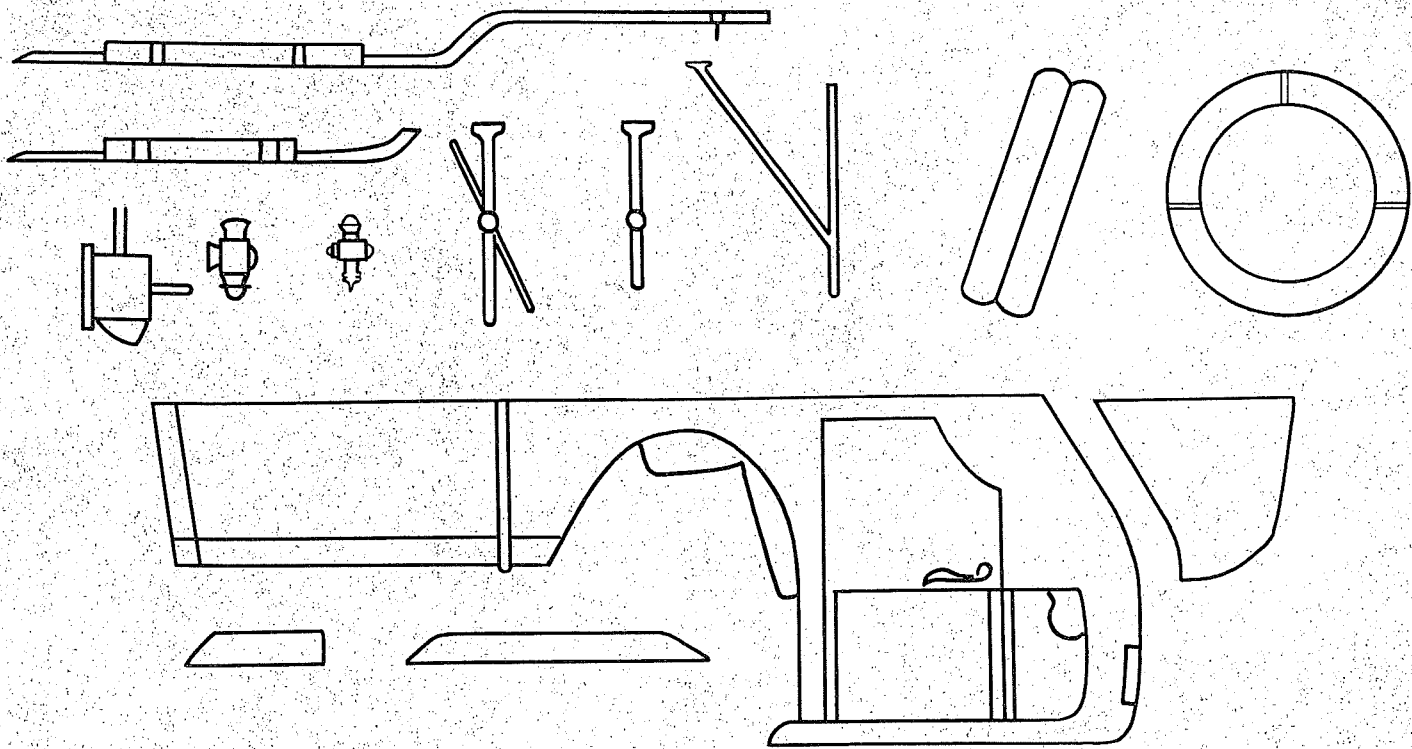

# Custom-Styling™ DESIGN SHEET



Use components and accessories from other design sheets to customize your hot rod. Add special rear view mirrors, "roll - bars" for hot rod racer models.

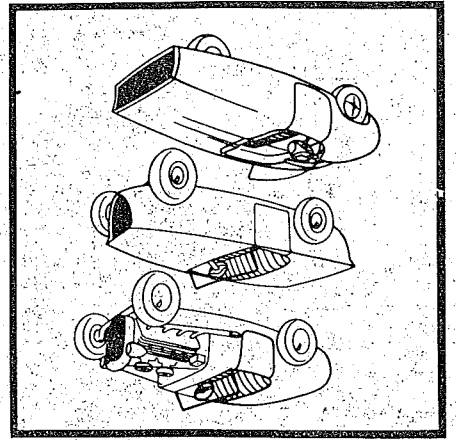

Design your own ornamental hub caps.

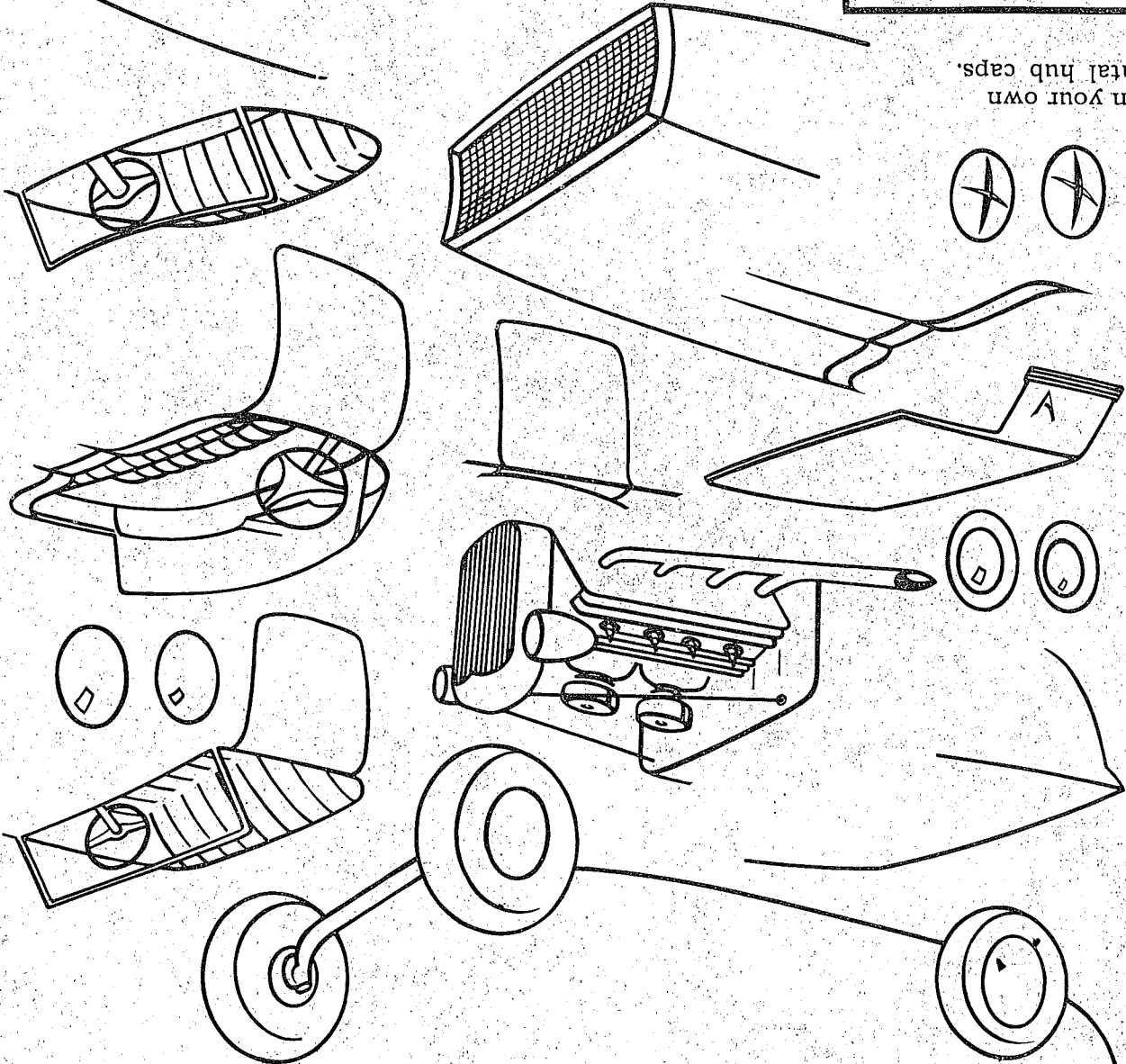

Designing hot rods is as much fun as driving! Draw the kind of hot rod you would like to own, using this sheet for ideas. Draw front or rear engine hot rods. Decorate and color them as you please, and don't forget to customize the seats!

DESIGN SHEET

Custom-Styling™

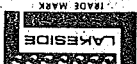

Use different designs, colors and names on all the runabouts you draw. Try to develop your own ideas. Some different kinds of water scenes and sporting events. Draw a runabout towing a water skier or show several boats in a race. Look in sports and boating magazines for more ideas.

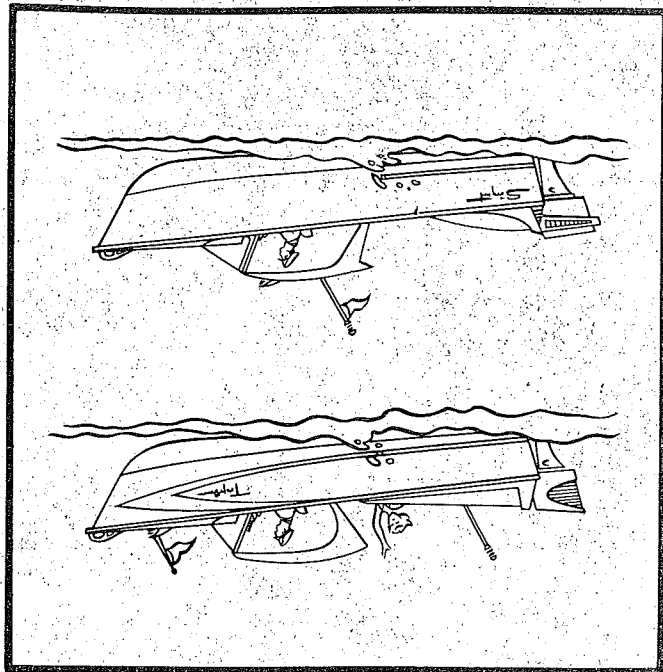

Customize your hull design and name your craft.

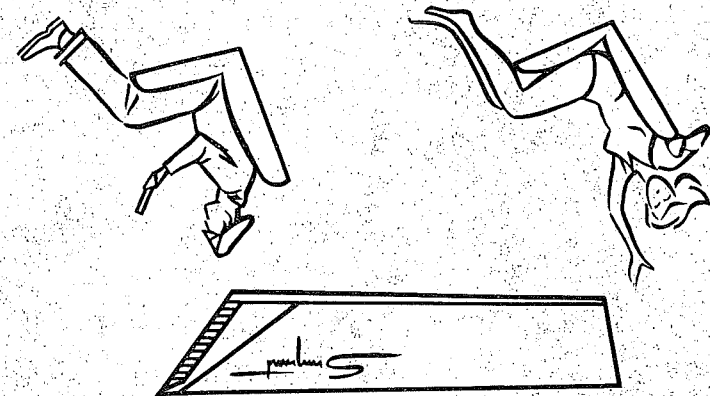

Design a runabout!

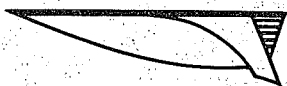
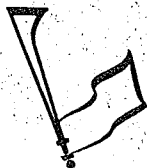
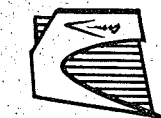

Design your own inboard or outboard hull.

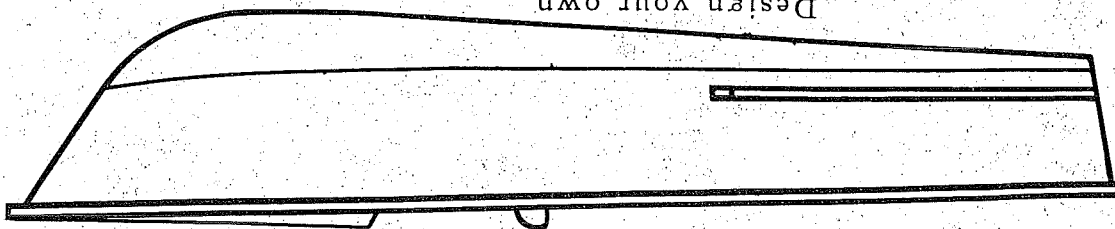

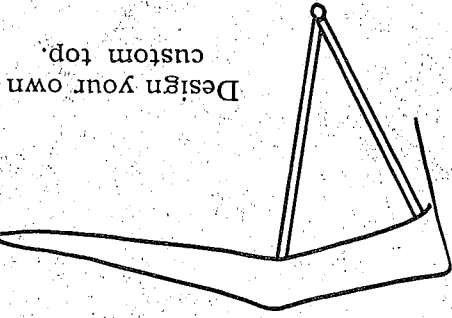
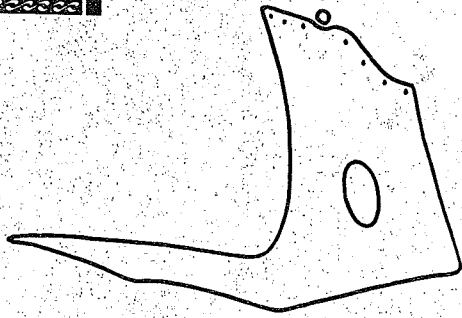
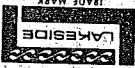

Design your own custom top.

ANTIQUE MODELS  
On this and on the accompanying design sheet you will find many ideas creating custom antique automobiles. All drawings are interchangeable and reversible. Merely turn the sheet over to reverse the direction or application of the component.  
A part of the fun in making custom antique cars is in naming them and coloring them. When finished, they make attractive and distinctive wall decorations.

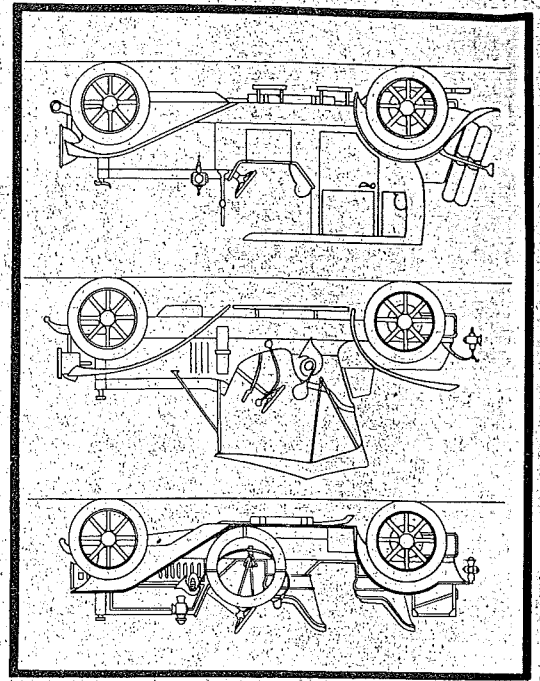

Below are shown only 3 ideas for drawings. Design others.

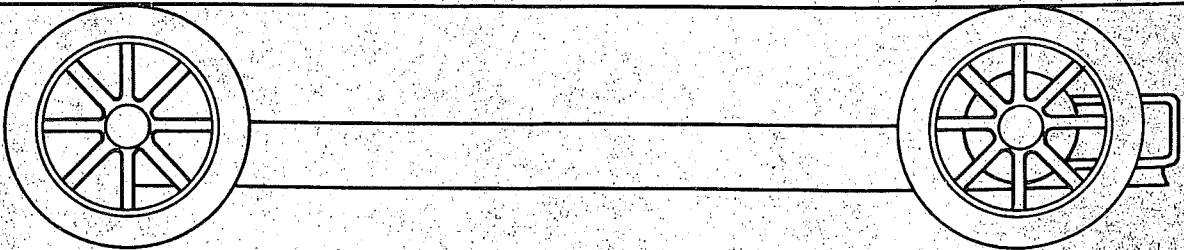
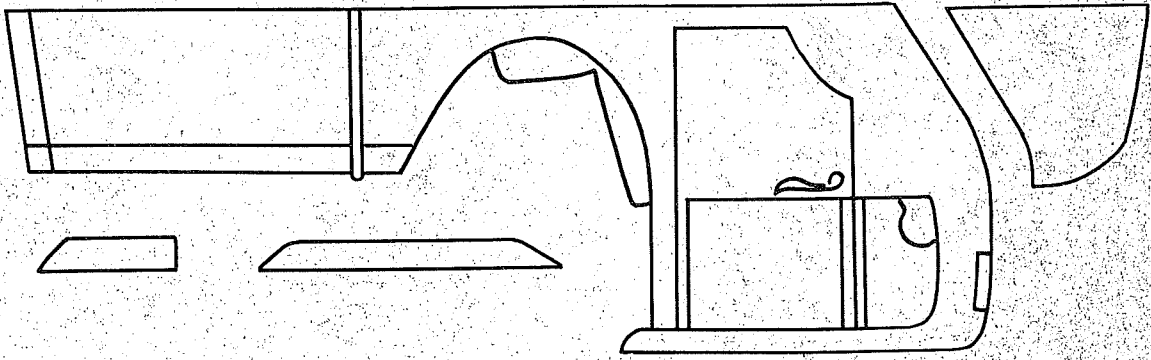
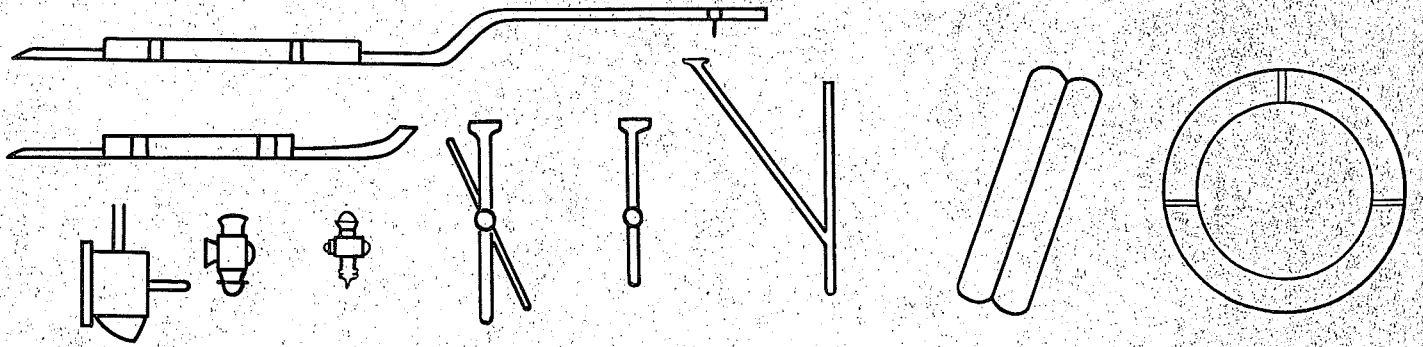

# Custom-Styling™ DESIGN SHEET

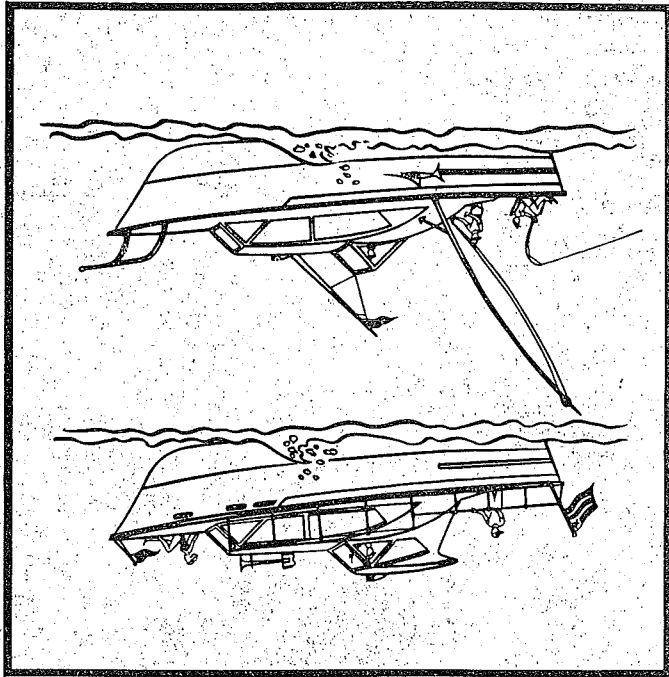

Show deep sea cruisers in action! Cruisers are made for fun so when you have designed your ideal craft, put some fun in your illustration. Show a swordfish being caught. Or show a skier or aqua-planer being towed. Draw a scene showing several cruisers racing. Put other kinds of pleasure and sports craft in your design pictures.

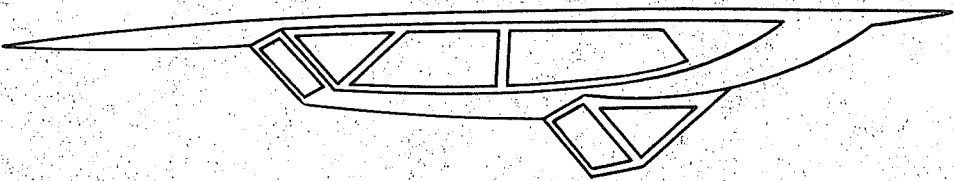
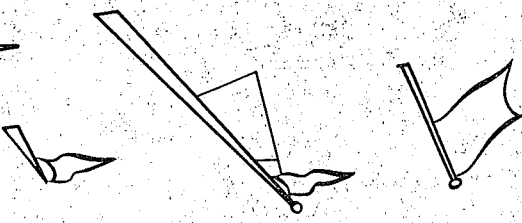
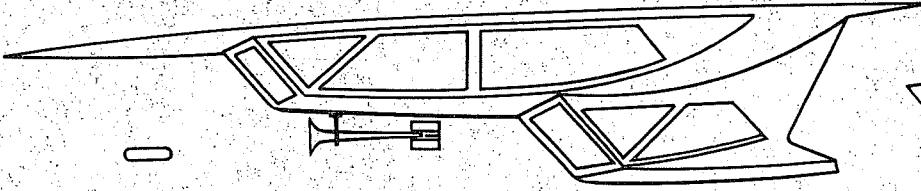
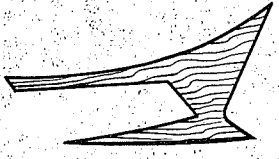
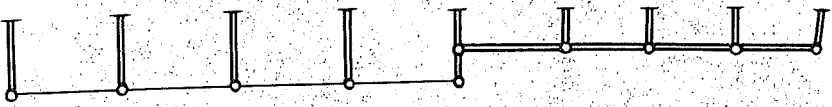
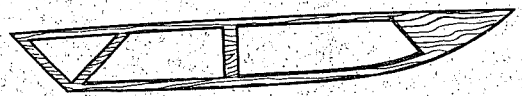
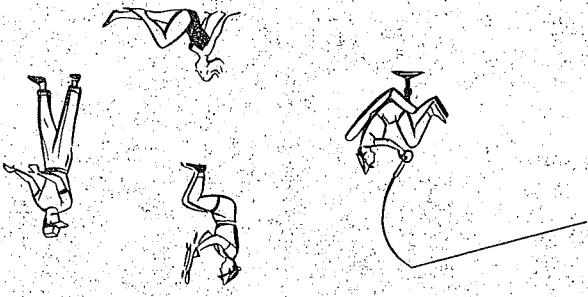

Design a deep sea cruiser!



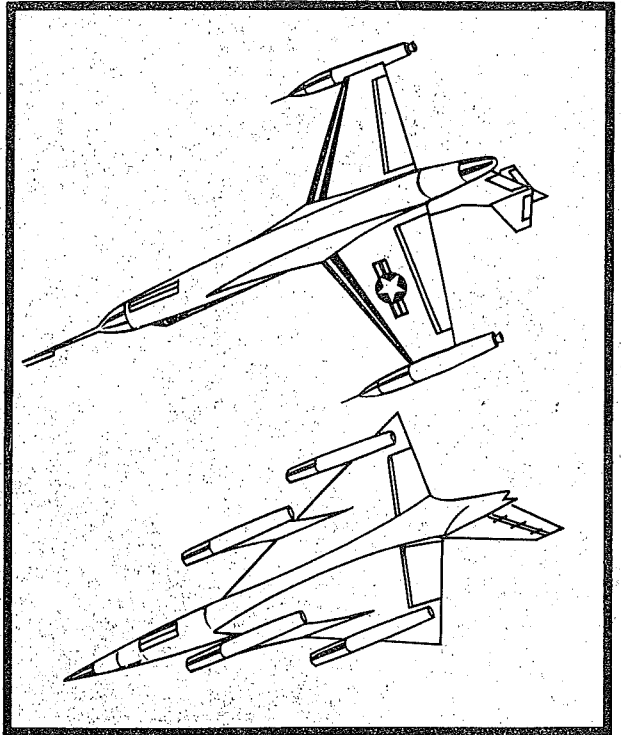
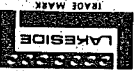

Design a super jet fighter or multiple engine high altitude bomber. Draw several jets of your own design and show them in various formations or performing difficult maneuvers. Make your drawings and designs more realistic by adding backgrounds of blue sky, clouds and jet vapor trails. For the latest ideas in aircraft design, look in aviation magazines.

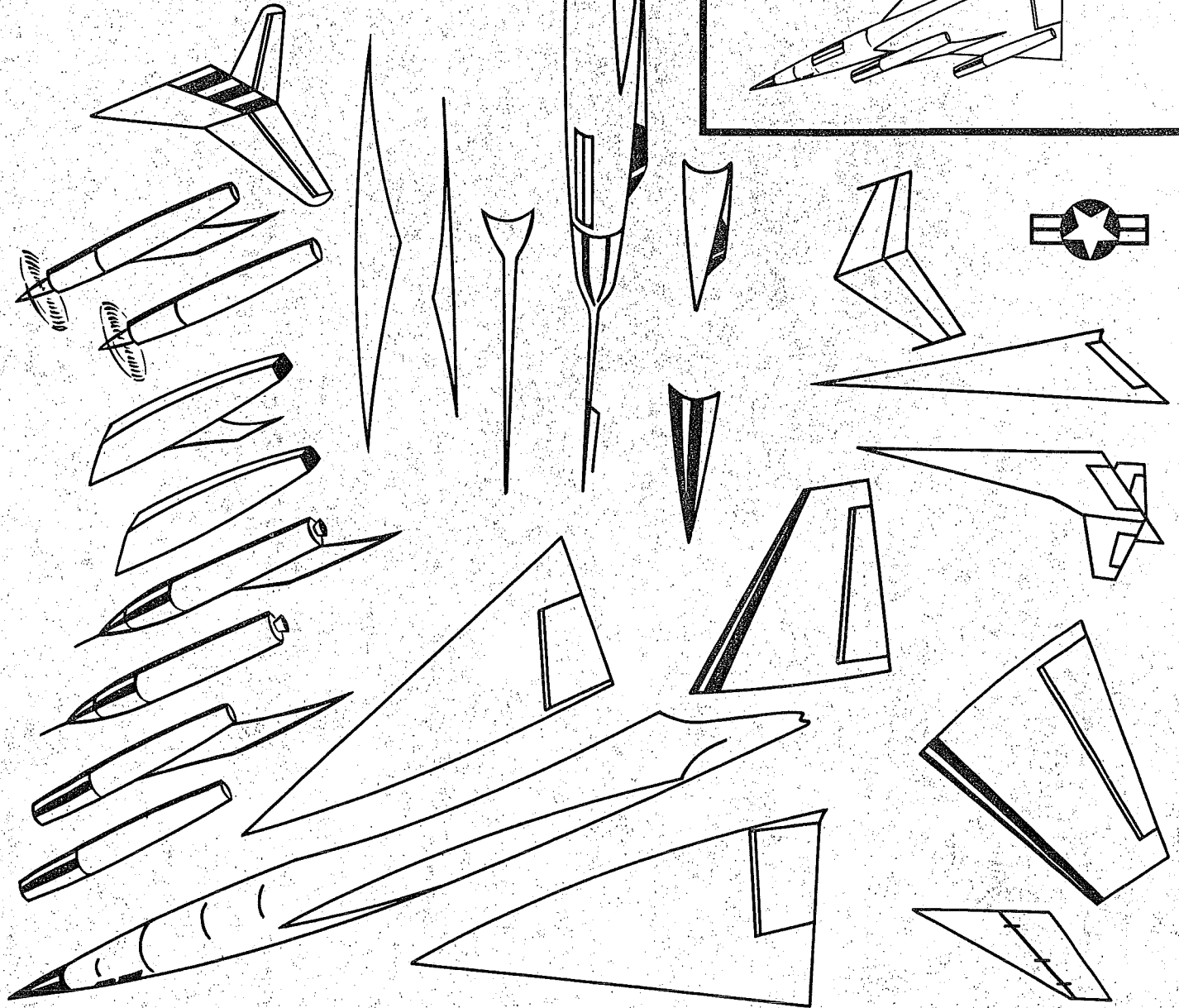



# Custom-Styling™ DESIGN SHEET

The space traveler is weightless because he moves in a vacuum.



Design your own space vehicle and spaceman's interstellar safety suit. Show the spaceman assembling or repairing a rocket, platform or station.

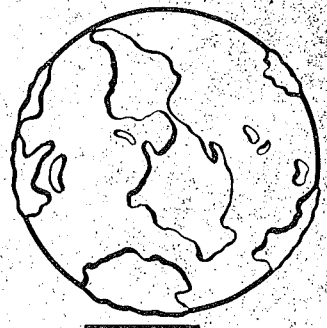
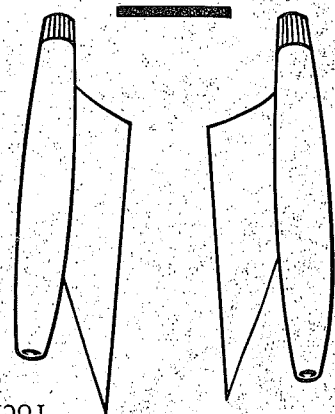
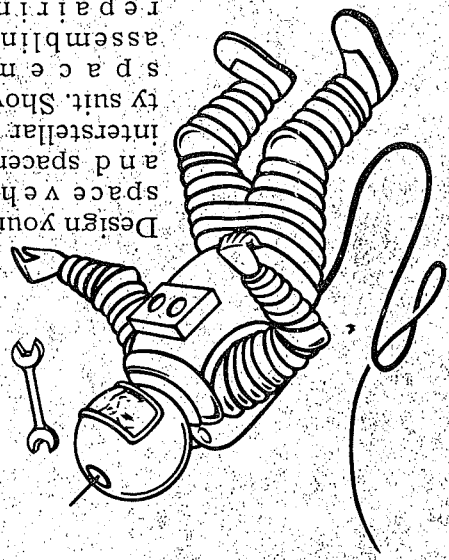

U.S. ARMY  
3656770

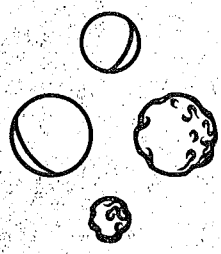

Show different stars and planets in a space scene.

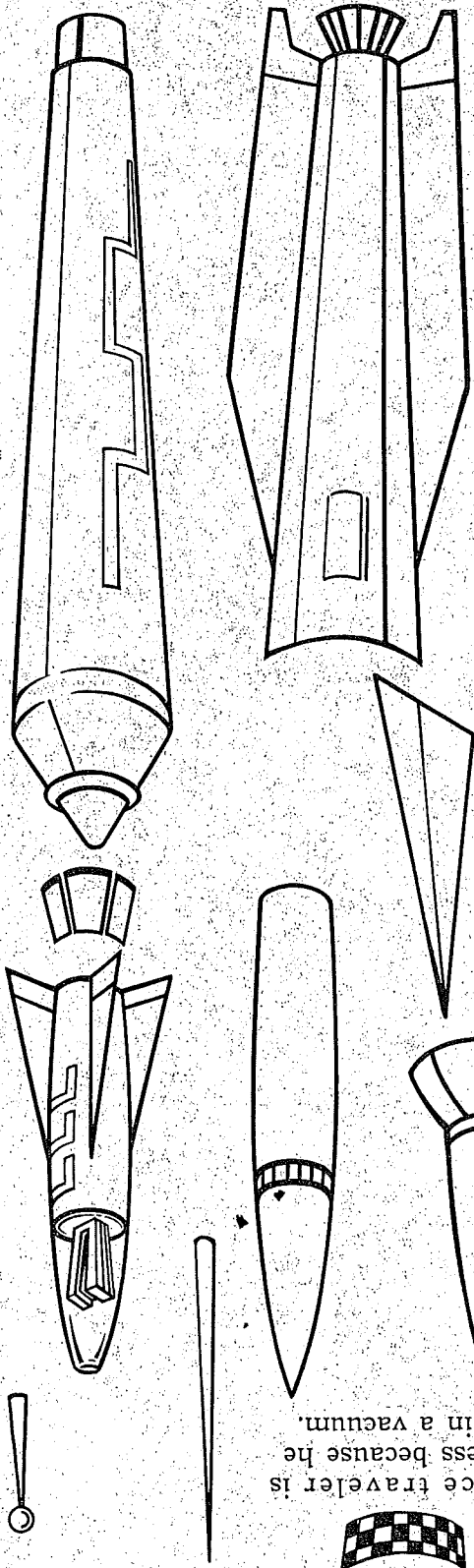
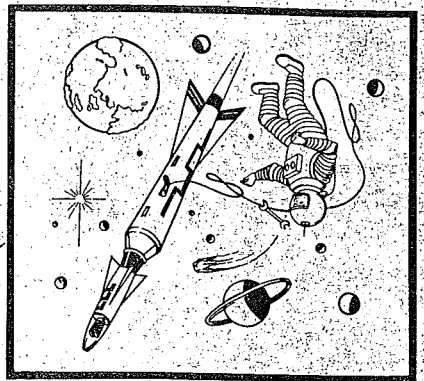

Begin a collection of new space vehicles and pictures of the stars and planets. Keep them in your portfolio for future designing ideas.

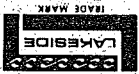

Here is lots of racing fun! Now you can design dozens of racing boats of all kinds. On outboard engine models you can draw your own super engine with your own name label. On inboard models draw in your own supercharger system. Be sure to use different colors and designs on your hulls, hull decorations, helmets and pennants. Use a single sheet and draw several models in racing positions. For more ideas, look in boating magazines.

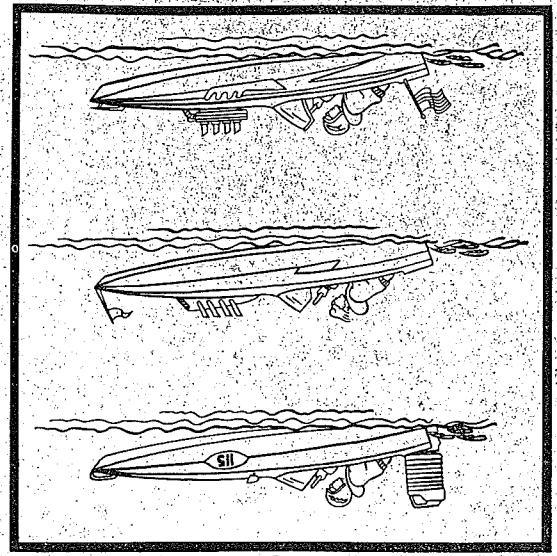

Custom design cabins, deck fins and engines.

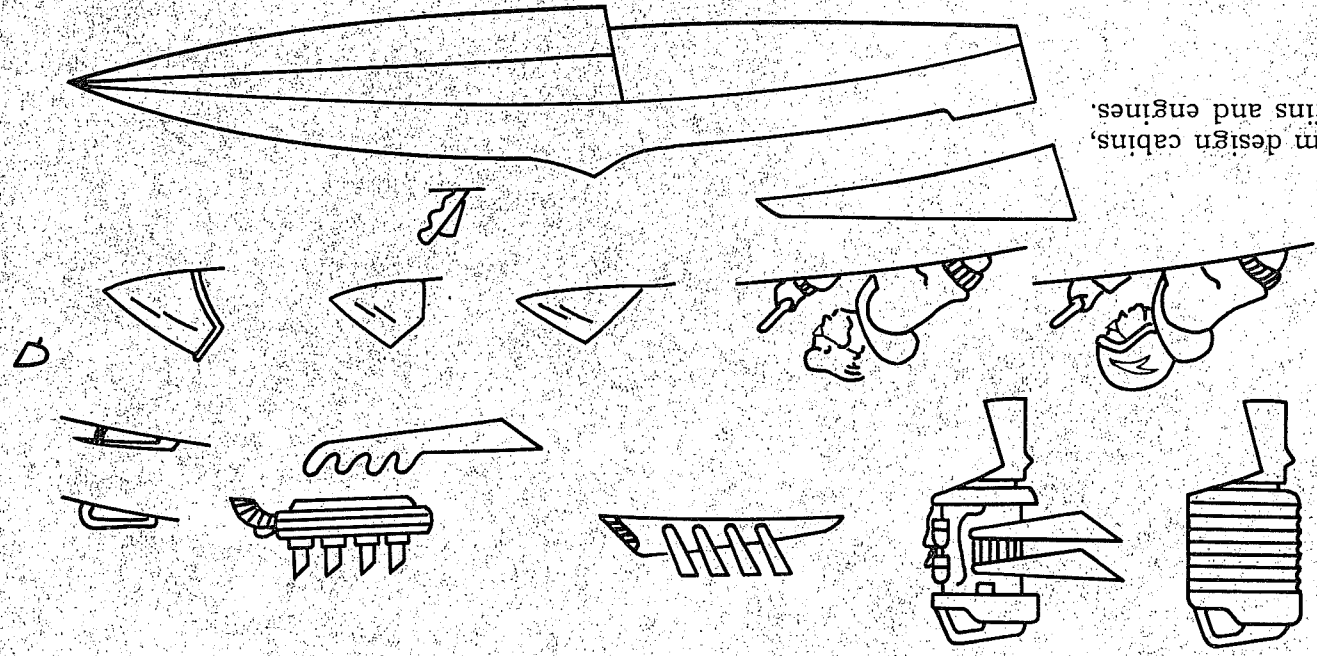

Design a hydroplane racer!

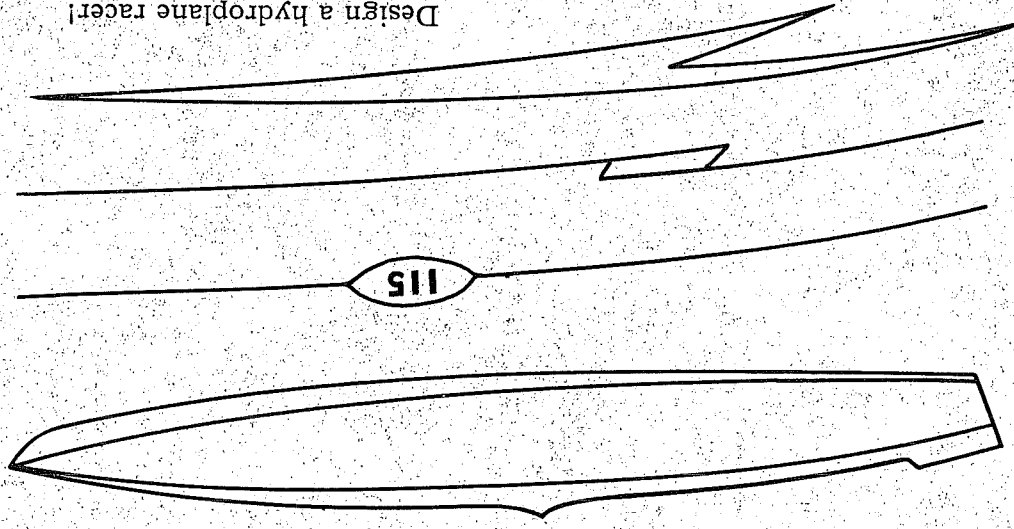



Draw a coat of arms on the door or hood.

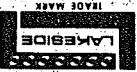

Fenders, hoods and grills may be decorated with pin stripping or other ornamental techniques. Try designing your own wheel covers, spokes or hub caps.

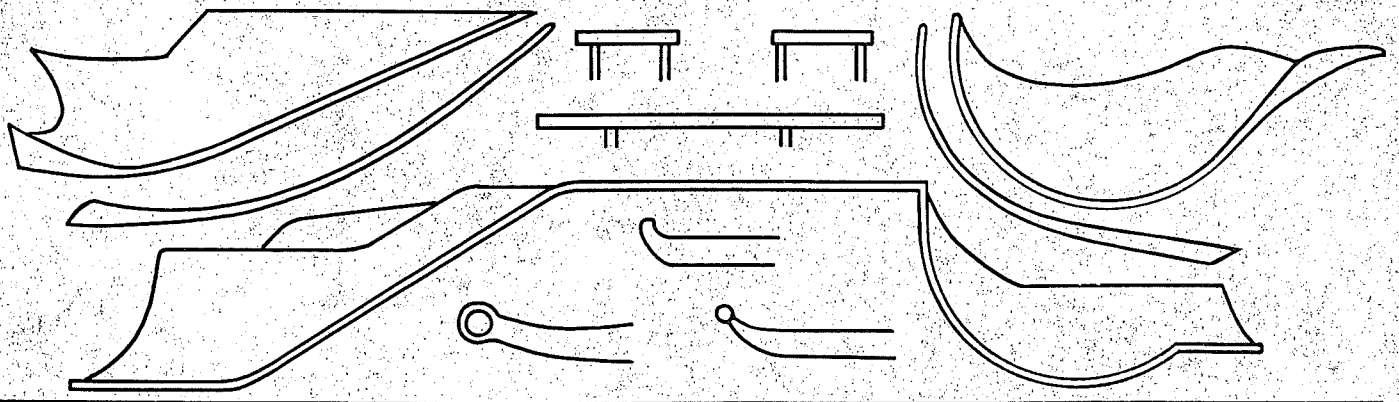
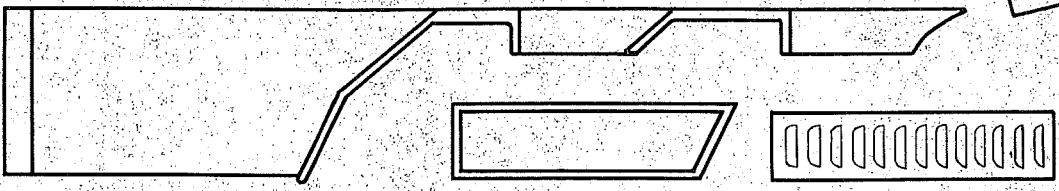
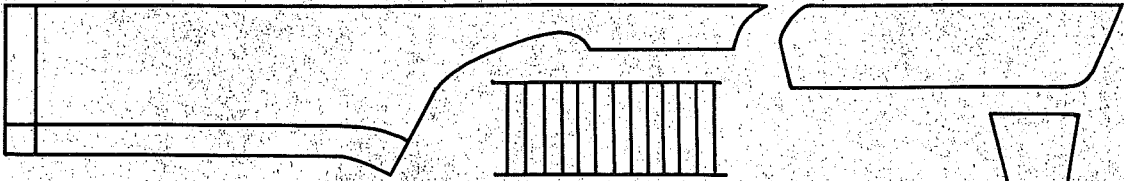
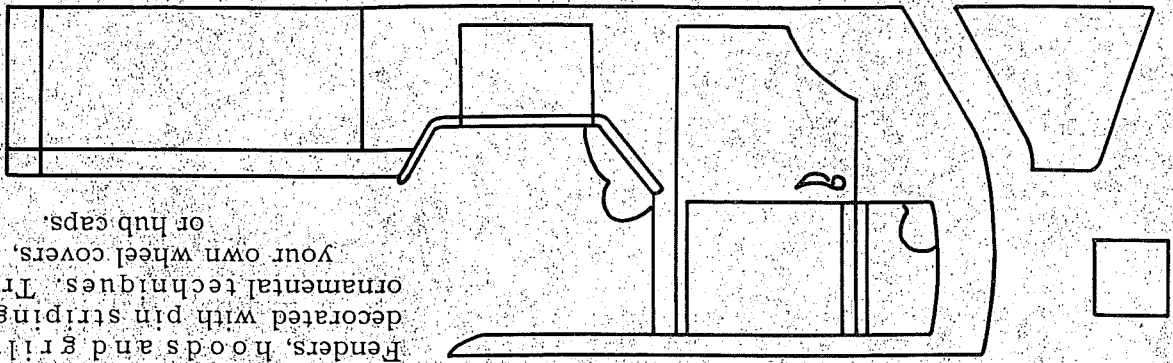

Show a man driving your car and dressed in duster smock, cap and goggles.

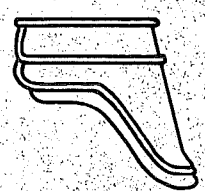
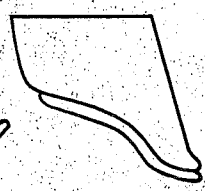
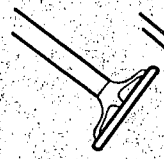
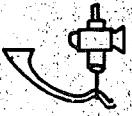
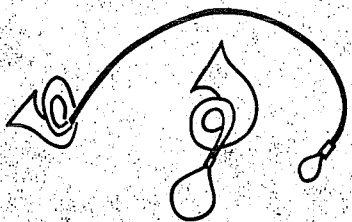
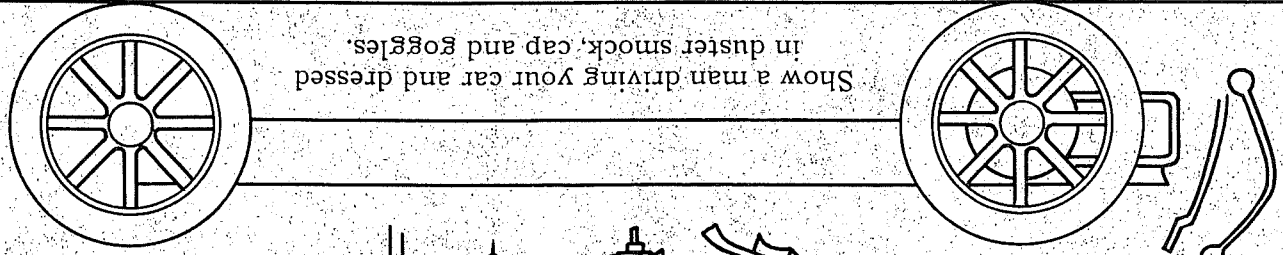



You can have lots of fun with an air fleet of your own design! Draw all kinds of private monoplanes, dual engine and jet aircraft. By changing the position of your design sheet you can show aircraft in different formations. You can draw your own airport scenes or show aircraft racing and stunting. Look in aviation magazines for more ideas and the latest designs.

### DESIGN YOUR PLANE!

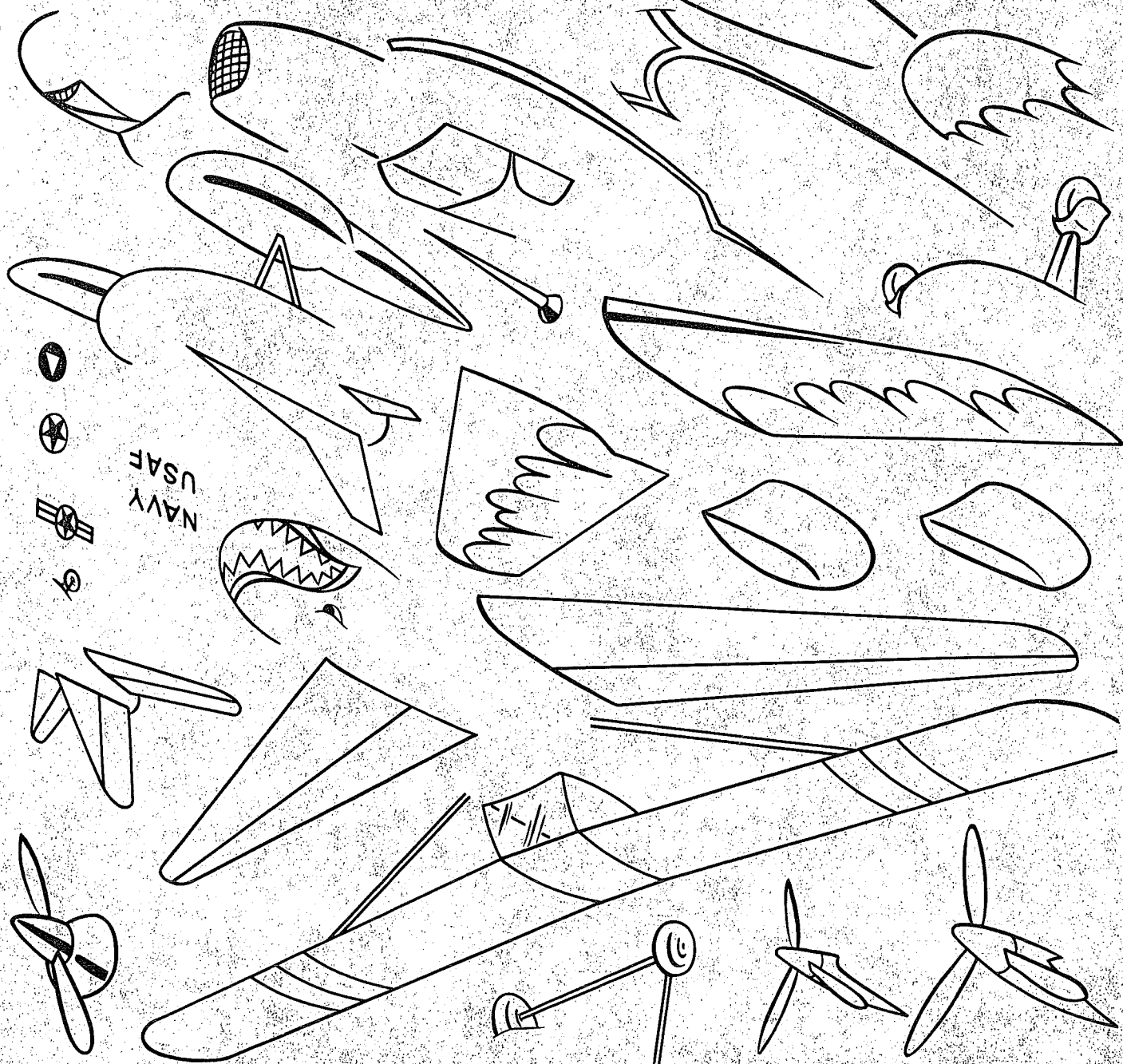
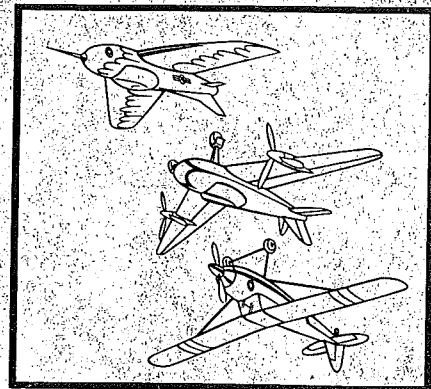

# Custom-Styling™

DESIGN SHEET

# Custom-Styling™ DESIGN SHEET

Draw a continental rear wheel kit on this sports coupe. Add a chrome or decorated spare wheel cover. Design your own rear deck, fenders and stylized fender skirts. Get ideas from this and other design sheets.

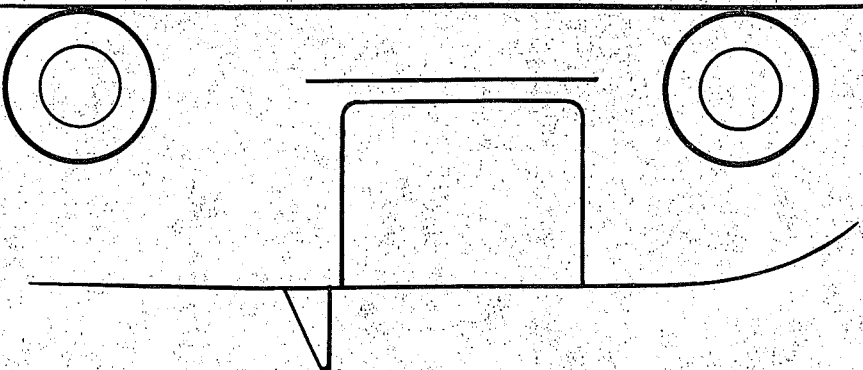

If you really want to get fancy, decorate the tires! Try several designs and colors before you apply them to your sports coupe. To make a hot rod sports coupe, leave off the front deck or hood and leave the engine exposed.

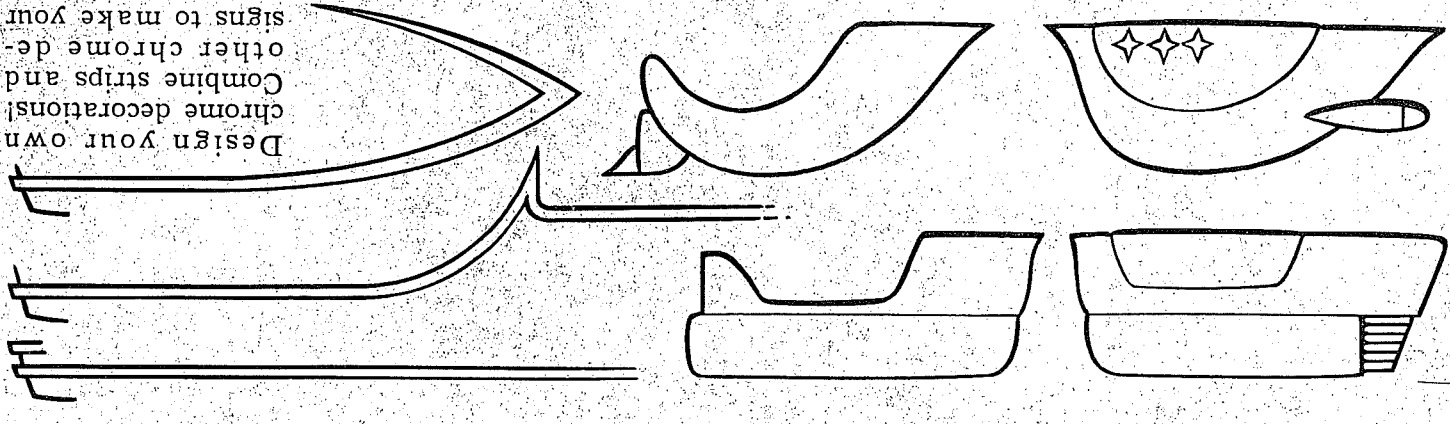

Design your own chrome decorations! Combine strips and other chrome designs to make your own special trimmings.

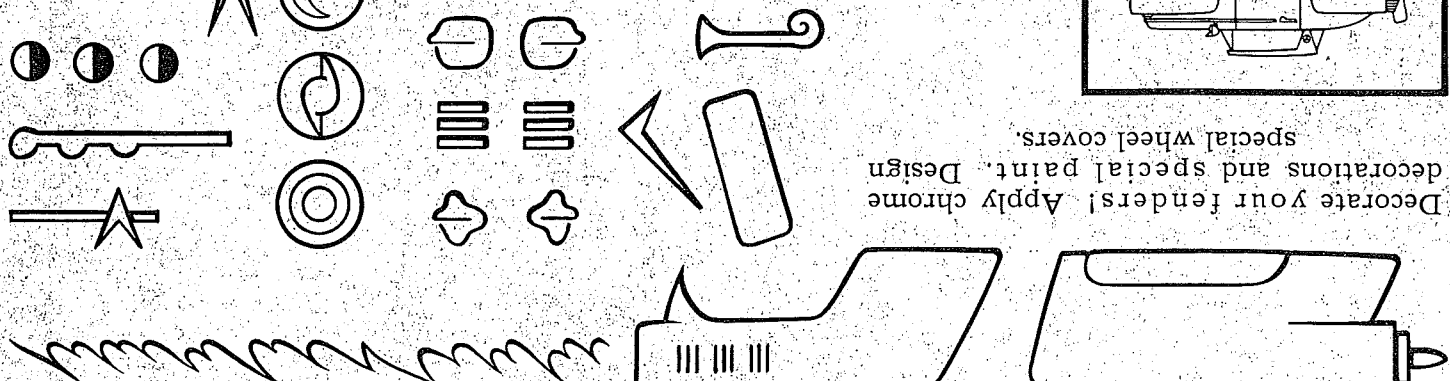

Decorate your fenders! Apply chrome decorations and special paint. Design special wheel covers.

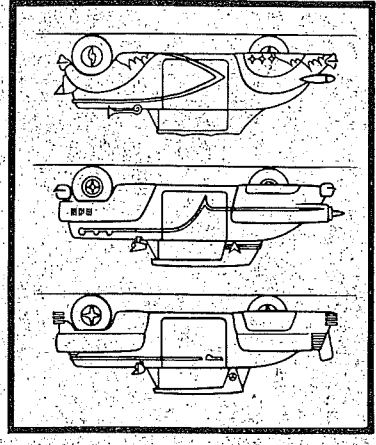

You can make any one car design look completely different just by changing the colors. When you have finished a car you like, trace over it and use a new color scheme. Get more ideas for designing and coloring from other design sheets and from magazines.

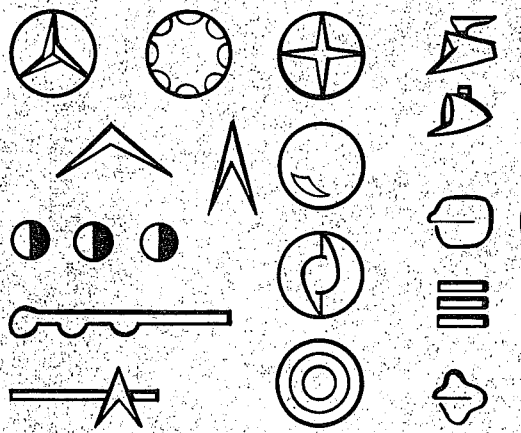

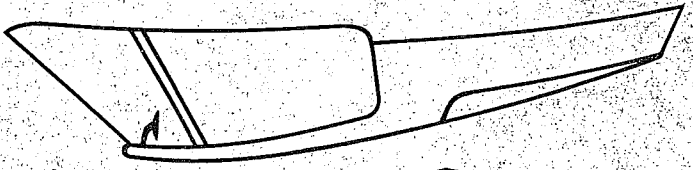
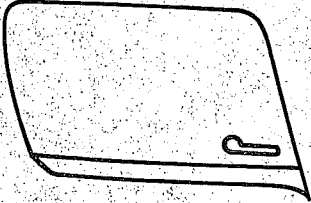
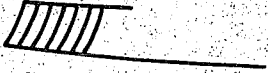
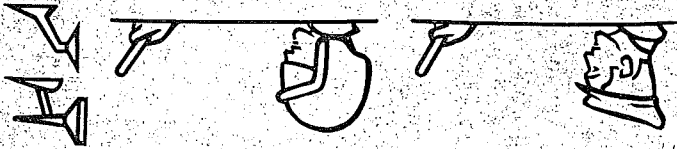
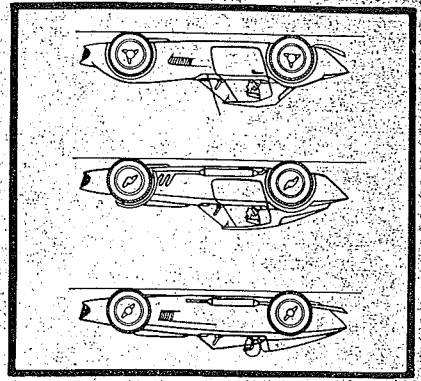

Mount ornaments or mirrors and pennants on front fenders. Try drawing your own design with wire wheels.

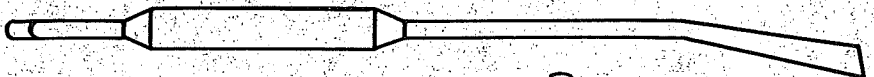
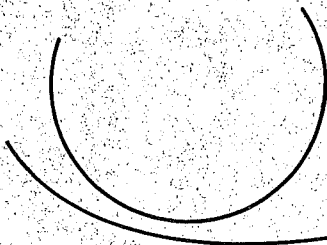
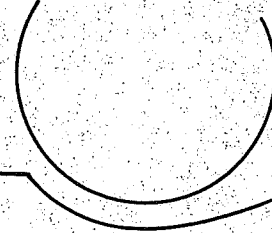

Modify fins on front and rear decks as you choose. If you like, mount headlights, spotlights, back-up lights or wing turn signals on your models.



Custom sports cars are easy to design. Make up your own ideas for sculpting bodies. Design your own windows, windshields and rear view mirrors.

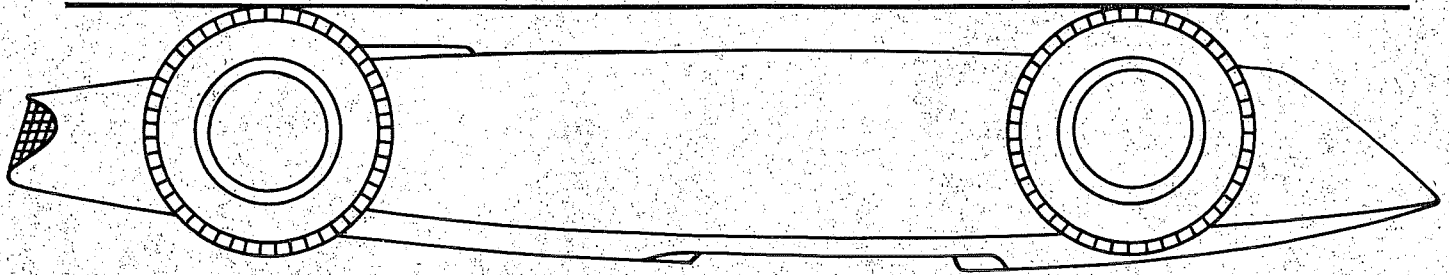
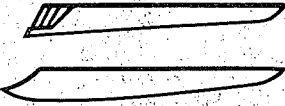
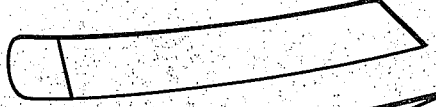
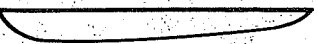

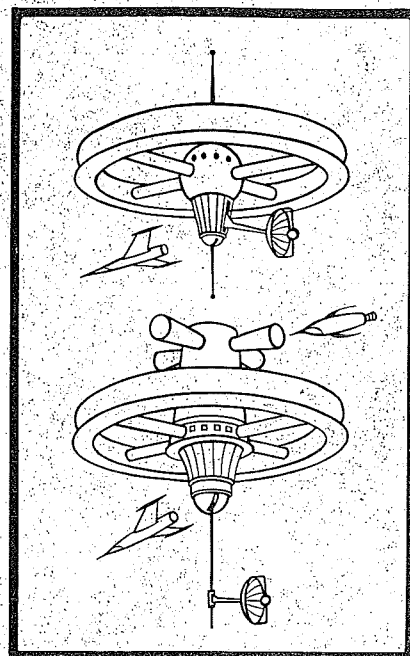
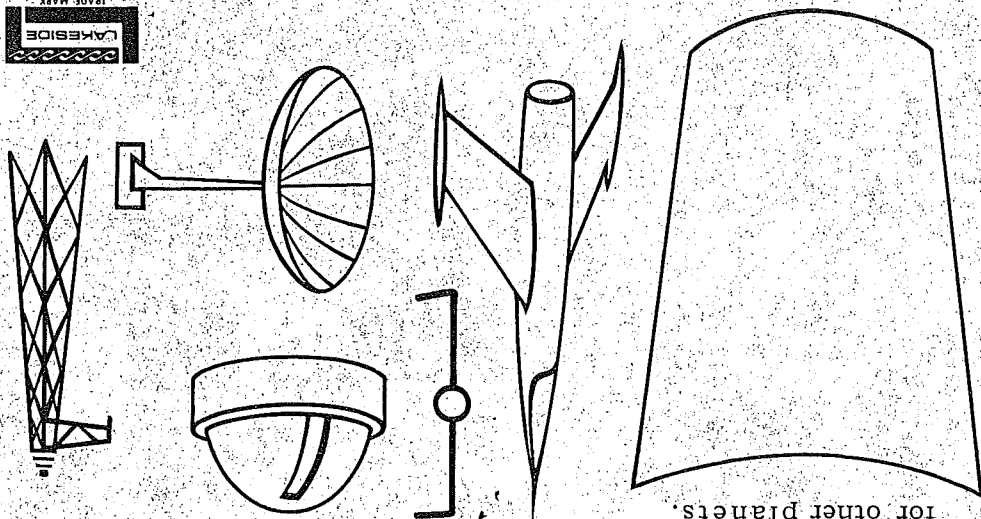

Design your own space platform and interstellar launching station. Draw scenes showing rockets arriving and departing for other planets. Use components from other sheets to help carry out your ideas.

